

Поставщик:  
**ОБЩЕСТВО С ОГРАНИЧЕННОЙ ОТВЕТСТВЕННОСТЬЮ**  
**"ИНТЕХСЕРВИС"**

109548, г.Москва, ул.Гурьянова, д.2, корп.2  
Тел./факс:8(499)786 01 03  
www.ITS77.ru E-mail:ITS77@mail.ru



COLLETS & TAPPING ADAPTERS  
PINZAS Y ADAPTADORES PORTAMACHOS

14

WWW

DESCRIPTION DENOMINACION	Page Pag.
DIN 6388 COLLETS Form A For plain straight shank tools PINZAS DIN 6388 Forma A Sujeción de mangos cilíndricos lisos	14/3
DIN 6388 COLLETS Form E For threaded straight shank tools PINZAS DIN 6388 Forma E Sujeción de mangos cilíndricos roscados	14/3
DIN 6388 COLLETS Form B (With clamping field) For plain straight shank tools PINZAS DIN 6388 Forma B (Gran elasticidad) Sujeción de mangos cilíndricos lisos	14/4
COLLETS FOR TAPPING CHUCKS For cylindrical straight shanks with square DIN 10 PINZAS PARA PORTAMACHOS Sujeción de mangos cilíndricos con cuadradillo	14/4
DIN 6499 (ER TYPE) COLLETS Form B For plain cylindrical straight shank PINZAS DIN 6499 Forma B (TIPO ER) Sujeción de mangos cilíndricos lisos	14/5
DIN 6499 (ER TYPE) COLLETS For taps shanks PINZAS DIN 6499 (TIPO ER) Sujeción de mangos cilíndricos lisos con cuadradillo	14/5
DIN 6499 (ER TYPE) SEALED-BY-DESIGN COLLETS - HERMETIC 100% STEEL. For plain cylindrical straight shanks with through coolant channels PINZAS DIN 6499 (TIPO ER) HERMÉTICA 100% Acero. Sujeción de mangos cilíndricos lisos con paso de refrigeración	14/6
DIN 6499 (ER TYPE) SEALED-BY-DESIGN COLLETS - HERMETIC 100% STEEL. For plain cylindrical straight shanks without through coolant channels PINZAS DIN 6499 (TIPO ER) HERMÉTICA 100% Acero. Sujeción de mangos cilíndricos lisos sin paso de refrigeración	14/6
ER-SHRINK FIT EXTENSIONS PROLONGADORES DE CONTRACCIÓN TÉRMICA Con forma de pinza (TIPO ER)	14/7
STRAIGHT COLLETS FOR GREAT POWER COLLET CHUCKS For tools with plain cylindrical straight shank PINZAS PARA PORTAPINZAS DE GRAN APRIETE. Sujeción de mangos cilíndricos lisos	14/9

DESCRIPTION DENOMINACION	Page Pag.
QUICK CHANGE REDUCING ADAPTERS Bilz type REDUCTORES PARA ADAPTADORES DE CAMBIO RÁPIDO TIPO BILZ	14/10
QUICK CHANGE TAPPING ADAPTERS Bilz type Positive drive adapters ADAPTADORES DE CAMBIO RÁPIDO TIPO BILZ Sin embrague	14/10
QUICK CHANGE TAPPING ADAPTERS Bilz type Positive drive adapters for light machining only ADAPTADORES DE CAMBIO RÁPIDO TIPO BILZ Sin embrague y trabajos de poco esfuerzo	14/10
QUICK CHANGE TAPPING ADAPTERS Bilz type Torque release (with clutch) adapters ADAPTADORES DE CAMBIO RÁPIDO TIPO BILZ Con embrague	14/10
QUICK CHANGE TAPPING ADAPTERS Bilz type Torque release (with clutch) adapters for light machining only ADAPTADORES DE CAMBIO RÁPIDO TIPO BILZ Con embrague y trabajos de poco esfuerzo	14/11
DIN 6328 TAPPING COLLETS For tools with cylindrical straight shank with square DIN 10 PINZA DIN 6328 Sujeción de machos de roscar	14/11
DIN 6329 DRILL COLLETS For tools with cylindrical straight shank according to DIN 1809 PINZA DIN 6329 Sujeción de brocas	14/11
DIRECT COUPLING COLLETS ISO DIN 2080 Taper PINZAS DE ACOPLAMIENTO DIRECTO Cono DIN 2080	14/11
DIRECT COUPLING COLLETS R-8 BRIDGEPORT PINZA DE ACOPLAMIENTO DIRECTO Cono R-8 BRIDGEPORT	14/11
COLLETS CHUCKS SETS CONJUNTOS DE PORTAPINZAS	14/12 14/13

**002 01 ... ..**

**FORM A - FORMA A**

For plain straight shank tools  
(tolerance h10)

Sujeción de mangos cilíndricos lisos  
(tolerancia h10)

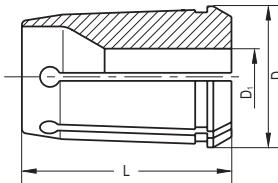

- To order: COD. + D<sub>1</sub>  
EXAMPLE:002 01 04/10
- For sets see page 262
- Material: Tempered spring steel
- Hardness: 56 ÷ 58 HRC

- Forma de pedido: COD. + D<sub>1</sub>  
EJEMPLO:002 01 04/10
- Para conjuntos ver pág. 262
- Material: Acero de temple
- Dureza: 56 ÷ 58 HRc

COD.	D	L	D <sub>1</sub>	Clamping field Campo
002 01 01	11,5	21	2 .....	6 —
002 01 02	17,2	30	2 .....	10 —
002 01 03	25,5	40	2 .....	16 —
002 01 04	29,8	45	2 .....	20 —
002 01 05	35,05	52	2 .....	25 —
002 01 06	43,7	60	2 .....	32 —
002 01 07	52,5	68	2 .....	40 —
002 01 08	63,8	80	2 .....	50 —

**002 03 ... ..**

**FORM E - FORMA E**

For threaded straight shank tools

Sujeción de mangos cilíndricos  
roscados

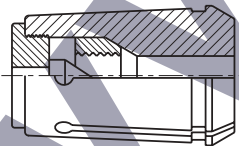

COD.	D	L	D <sub>1</sub>	Clamping field Campo
002 03 03	25,5	40	6	—
002 03 04	29,8	45	6-8-10-12-16	—
002 03 05	35,05	52	6-8-10-12-16-20	—
002 03 06	43,7	60	6-8-10-12-16	—
002 03 07	52,2	68	12-16-25	—
002 03 08	63,8	80	20-25-32-38	—

- To order: COD. + D<sub>1</sub>  
EXAMPLE:002 03 04/10
- For sets see page 262

- Forma de pedido: COD. + D<sub>1</sub>  
EJEMPLO:002 03 04/10
- Para conjuntos, ver pág. 262

- Material: Tempered spring steel
- Hardness: 56 ÷ 58 HRC

- Material: Acero de temple
- Dureza: 56 ÷ 58 HRc

## 002 04 ... ..

**FORM B - FORMA B**  
(With clamping field)  
For plain straight shank tools  
(Gran elasticidad)  
Sujeción de mangos cilíndricos lisos

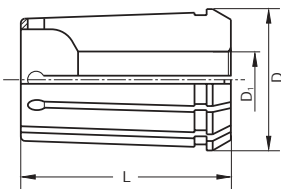

COD.	D	L	D <sub>1</sub>	Clamping field Campo
002 04 03	25,5	40	5 ..... 16	- 0,5
002 04 04	29,8	45	6 ..... 20	- 0,5
002 04 05	35,05	52	6 ..... 25	- 0,5
002 04 06	43,7	60	6 ..... 32	- 0,5
002 04 07	52,2	68	9 ..... 40	-0,5

- To order: COD. + D<sub>1</sub>  
EXAMPLE: 002 04 04/10
- Material: Tempered spring steel
- Hardness: 46 ÷ 48 HRc
- Forma de pedido: COD. + D<sub>1</sub>  
EJEMPLO: 002 04 04/10
- Material: Acero de temple
- Dureza: 46 ÷ 48 HRc

For cylindrical straight shanks with square DIN 10  
Sujeción de mangos cilíndricos DIN 10

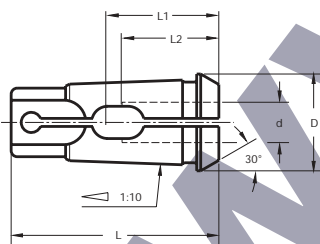

COD.	CAP.	D	L	d	Φ	L <sub>1</sub>	L <sub>2</sub>
				2,5	2,1	19	15
				2,8	2,1	19	15
				3,15	2,5	22	18
				3,5	2,7	21	16
				3,55	2,8	22	18
				4	3	21	16
				4,5	3,4	21	16
				5	4	25	19
				5,5	4,3	24	18
				5,6	4,5	25	19
002 19 03	M3-M16	25,4	52	6	4,9	26	19,5
				6,3	5	28	22
				7	5,5	26	19,5
				7,1	5,6	28	22
				8	6,2	27	19,5
				9	7	30	22
				10	8	32	23
				11	9	34	24
				11,2	9	36	26
				12	9	36	25
				12,5	10	36	26
				6	4,9	26	19,5
				6,3	5	28	22
				7	5,5	26	19,5
				7,1	5,6	28	22
				8	6,2	27	19,5
				9	7	30	22
				10	8	32	23
002 19 04	M8-M28	29,8	63	11	9	34	24
				11,2	9	36	26
				12	9	36	25
				12,5	10	36	26
				14	11	38	26
				16	12	44	30
				18	14,5	48	33
				20	16	52	35

- To order: COD. + d x Φ  
EXAMPLE: 002 01 04/10
- Material: Tempered spring steel
- Hardness: 57 ÷ 60 HRc
- Forma de pedido: COD. + d x Φ  
EJEMPLO: 002 19 03/4 x 3
- Material: Acero de muelles Templado
- Dureza: Rc 57 ÷ 60 HRc

**002 11 .....**  
**FORM B - FORMA B**  
For plain cylindrical straight shank  
Sujeción de mangos cilíndricos lisos

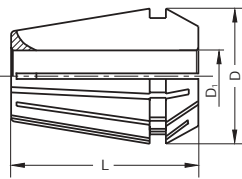

ER	COD.	D	L	D <sub>1</sub>	Clamping field Campo
ER-8	002 11 01	8,5	13,5	1..... 5	- 0,5
ER-11	002 11 02	11,5	18	1..... 7	- 0,5
ER-16	002 11 03	17	17	1.....	-0,5
				2..... 10	-1
ER-20	002 11 04	21	31	2..... 13	-1
ER-25	002 11 05	26	35	2..... 16	-1
ER-32	002 11 06	33	40	2..... 20	-1
ER-40	002 11 07	41	46	4..... 26	-1
ER-50	002 11 08	52	60	12..... 34	-2

### ULTRAPRECISION

ER	COD.	D	L	D <sub>1</sub>	Clamping field Campo
ER-8	002 11 11	8,5	13,5	1..... 5	- 0,5
ER-11	002 11 12	11,5	18	1..... 7	- 0,5
ER-16	002 11 13	17	27	1.....	-0,5
				2..... 10	-1
ER-20	002 11 14	21	31	2..... 13	-1
ER-25	002 11 15	26	35	2..... 16	-1
ER-32	002 11 16	33	40	2..... 20	-1
ER-40	002 11 17	41	46	4..... 26	-1
ER-50	002 11 18	52	60	12..... 34	-2

**002 14 .....**  
For taps shanks  
Sujeción de mangos cilíndricos lisos  
con cuadradillo

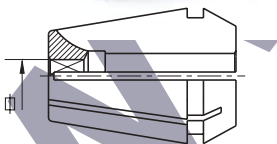

- To order: COD. + D<sub>1</sub>  
EXAMPLE: 002 11 04/10

- Forma de pedido: COD. + D<sub>1</sub>  
EJEMPLO: 002 11 04/10

ER	COD.	D	L	D <sub>1</sub>	Clamping field Campo
ER-16	002 14 03	17	27	3,5..... 7	—
ER-25	002 14 05	26	35	3,5..... 12	—
ER-32	002 14 06	33	40	4,5..... 16	—
ER-40	002 14 07	41	46	6..... 20	—
ER-50	002 14 08	52	60	8..... 32	—

- To order: COD. + D<sub>1</sub> + □  
EXAMPLE: 002 14 06/10/8

- Forma de pedido: COD. + D<sub>1</sub> □  
EJEMPLO: 002 14 06/10/8

• Assembly, see page 263

• Montaje, ver pág. 263

Material: Tempered spring steel  
Hardness: Rc 45 – 48.  
Accuracy: DIN 6499

Material: Acero de muelles templado.  
Dureza: Rc 45 – 48.  
Concentricidad: DIN 6499

**002 15 .....**

HERMETIC - 100% STEEL  
For plain cylindrical straight shanks  
with through coolant channels

HERMÉTICA - 100% ACERO  
Para herramientas de mango  
cilíndrico liso con paso de refrigeración

No pressure limit  
Sin límite de presión



ER	COD.	D	L	D <sub>1</sub>	Clamping field Campo
ER-16	002 15 03	17	27	3 ..... 5	—
				6 ..... 10	-0,5
ER-25	002 15 05	26	35	3 ..... 5	—
				6 ..... 16	-0,5
ER-32	002 15 06	33	40	3 ..... 6	—
				7 ..... 20	-0,5
ER-40	002 15 07	41	46	9 ..... 26	-0,5

- To order: COD. + D<sub>1</sub> - EXAMPLE: 002 15 06/10

Important: Use plain cylindrical straight shanks covering completely collet inside grinded surface.

- Forma de pedido: COD. + D<sub>1</sub> - EJEMPLO: 002 15 06/10

Atención: Para obtener el resultado deseado de refrigeración es necesario que el mango de la herramienta sea totalmente cilíndrico y a su vez debe ocupar la totalidad del diámetro rectificado de la pinza.



**002 16 .....**

HERMETIC - 100% STEEL  
For plain cylindrical straight shanks  
without through coolant channels

HERMÉTICA - 100% ACERO  
Para herramientas de mango cilíndrico  
liso sin paso de refrigeración

No pressure limit  
Sin límite de presión



ER	COD.	D	L	D <sub>1</sub>	Clamping field Campo
ER-16	002 16 03	17	27	3 ..... 4,5	—
				5 ..... 10	-0,5
ER-25	002 16 05	26	35	3 ..... 5,5	—
				6 ..... 16	-0,5
ER-32	002 16 06	33	40	3 ..... 5,5	—
				6 ..... 20	-0,5
ER-40	002 16 07	41	46	4 ..... 7,5	—
				8 ..... 26	-0,5

- To order: COD. + D<sub>1</sub> - EXAMPLE: 002 16 06/10

Important: Use plain cylindrical straight shanks covering completely collet inside grinded surface.

- Forma de pedido: COD. + D<sub>1</sub> - EJEMPLO: 002 16 06/10

Atención: Para obtener el resultado deseado de refrigeración es necesario que el mango de la herramienta sea totalmente cilíndrico y a su vez debe ocupar la totalidad del diámetro rectificado de la pinza.

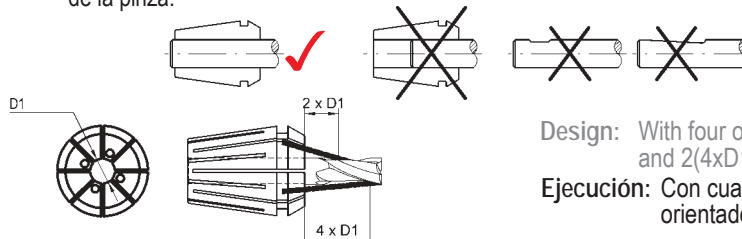

Design: With four oriented holes 2(2xD1) and 2(4xD1).

Ejecución: Con cuatro orificios de refrigerante orientados 2(2xD1) y 2(4xD1).

Material: Tempered spring steel  
Hardness: Hrc 45 – 48.  
Accuracy: DIN 6499

Material: Acero de muelles templado.  
Dureza: 45-48 Hrc.  
Concentricidad: DIN 6499

• Assembly, see page 263  
• Montaje, ver pág. 268

Adaptable a portapiñas tipo ER-32

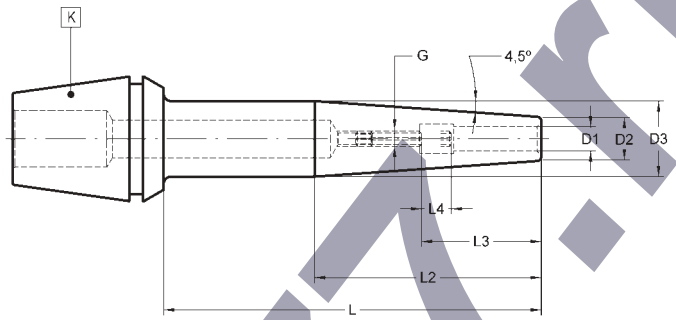

Desviación circular máxima entre K y D<sub>1</sub> ≤ 0,003

K	D <sub>1</sub>	D <sub>2</sub>	D <sub>3</sub>	L	L <sub>2</sub>	L <sub>3</sub>	L <sub>4</sub>	G	COD.	
ER-32	3	8	16	60	60	20	5	—	012 62 12 16 03	—
ER-32	4	9	16	60	60	20	5	—	012 62 12 16 04	—
ER-32	5	10	16	60	60	25	5	—	012 62 12 16 05	—
ER-32	6	12	16	60	60	36	10	M-5	012 62 12 16 06	301 02 33 05 01
ER-32	6	12	18	100	60	36	10	M-5	012 62 12 76 06	301 02 33 05 01
ER-32	8	14	18	60	60	36	10	M-6	012 62 12 16 08	301 02 33 06 01
ER-32	8	14	18	100	60	36	10	M-6	012 62 12 76 08	301 02 33 06 01
ER-32	10	16	20	60	60	42	10	M-8	012 62 12 16 10	301 02 33 08 01
ER-32	10	16	20	100	60	42	10	M-8	012 62 12 76 10	301 02 33 08 01
ER-32	12	18	20	60	60	47	10	M-10	012 62 12 16 12	301 02 33 10 01
ER-32	12	18	20	100	60	47	10	M-10	012 62 12 76 12	301 02 33 10 01

**Design:**

- For D<sub>1</sub> < 6, tool shank tolerance h4.
- For D<sub>1</sub> ≥ 6, tool shank tolerance h6.
- For Carbide, Cermet and HSS tool shanks according to DIN 6535 form HA and DIN 1835-1 form A.

**Delivery:**

- With built-in bored through stop screw.
- Other sizes and profiles on request.

**Ejecución:**

- Para mangos de herramienta con D<sub>1</sub> ≥ 6 tolerancia h6.
- Para mangos de herramienta con D<sub>1</sub> < 6 tolerancia h4.
- Para herramientas de Metal duro, Cermet y HSS con mango DIN 6535 forma HA y DIN 1835-1 forma A.

**Suministro:**

- Con tornillo de regulación con orificio para paso de refrigerante.
- Otras formas y tamaños bajo demanda expresa.



**ASSEMBLY AND REMOVAL OF  
DIN 6499 COLLETS (ER TYPE)  
AND DIN 6388 COLLETS**

**MONTAJE Y DESMONTAJE DE  
PINZAS DIN 6499 (TIPO ER) Y  
PINZAS DIN 6388**

A. Place collet inside nut and rotate the nut to engage collet groove with the eccentric ring. Push collet as shown in figure 1 until it clicks in.

A. Introducir la pinza en el interior de la tuerca haciendo coincidir el canal de la pinza con el diámetro de la excéntrica. Seguidamente aplicar una fuerza en el sentido de la flecha hasta escuchar un "clíc" (fig. 1).

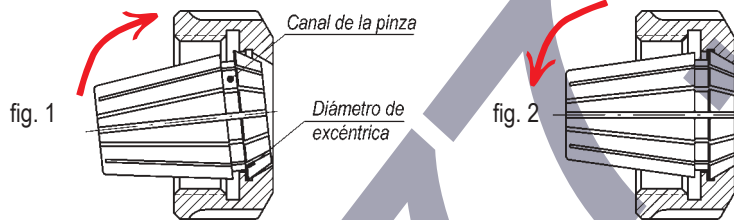

B. Remove: Unscrew nut from the toolholder. Apply opposite pressure to collet as shown in figure 2.

B. Para extraer la pinza del interior de la tuerca, basta con aplicar una fuerza semejante al de la fig. 1, pero de sentido contrario (fig. 2).

C. Never introduce the collet into the holder before collet is already assembled into the nut.

C. No introducir la pinza en el alojamiento del portapinzas y después la tuerca. Hacerlo siempre con el conjunto de pinza y tuerca montado.

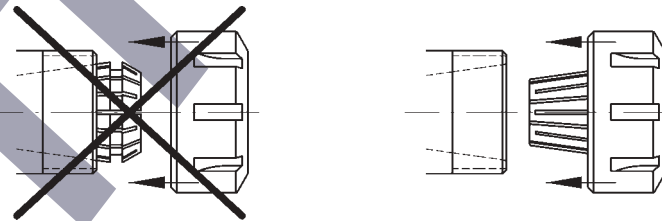

D. Tool shank should cover completely collet inside grinded surface.

D. El mango de la herramienta debe ocupar la totalidad del diámetro interior rectificado de la pinza.

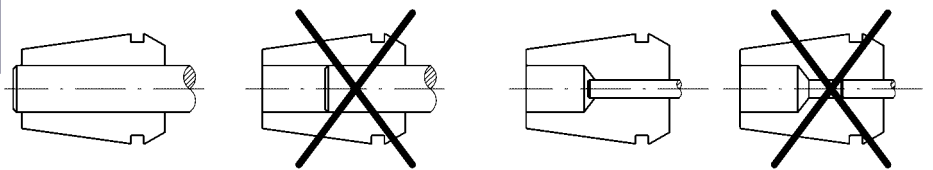

**CONCENTRICITY  
CONCENTRICIDAD**

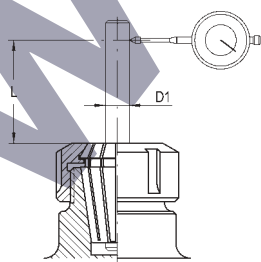

D <sub>1</sub>		L	Max. Deviation Desviación Máxima		
from más de	up to hasta		Precisin class-2	Precision class-1 (LAIP Standard)	Ultraprecision
1	1,6	6	0,015	0,010	0,005
1,6	3	10			
3	6	16			
6	10	25	0,020	0,015	0,010
10	18	40			
18	26	50			
26	34	60	0,025	0,020	0,010



**002 05 .. ..**

For tools with plain cylindrical straight shank

Sujeción de mangos cilíndricos lisos

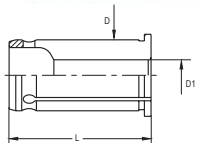

COD.	D	L	D <sub>1</sub>
002 05 03	16	40	3
002 05 04	20	52,5	3.....16
002 05 06	32	64,5	4.....26

- Forma de pedido: COD. + D<sub>1</sub>  
EJEMPLO: 002 05 06/10

- To order: COD. + D<sub>1</sub>  
EXAMPLE: 002 05 06/10

**002 05 .. ..**

HERMETIC - 100% STEEL

For tools with plain cylindrical straight shank

HERMÉTICA - 100% ACERO

Para herramientas con mango cilíndrico liso.

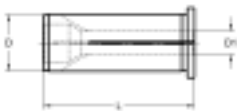

COD.	D	L	D <sub>1</sub>
002 05 14	20	52,5	3-4-5-6 ..... 14-15-16
002 05 16	32	64,5	3-4-5-6 ..... 24-25-26

- Forma de pedido: COD. + D<sub>1</sub>  
EJEMPLO: 002 05 16/10

- To order: COD. + D<sub>1</sub>  
EXAMPLE: 002 05 06/10

(\* It can be used with coolant trough cutting tools (except Ø 3). In this case plain cylindrical shank should be used and the cutting tool should cover completely the internal grinded surface as indicated in the drawing.

(\* Puede ser utilizado con herramientas con paso de refrigerante (excepto Ø 3). Para ello el mango debe ser cilíndrico y ocupar la totalidad de la zona rectificada interiormente según muestra el dibujo.

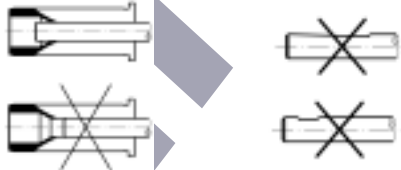

**002 09 .. ..**

HERMETIC - 100% STEEL

For tools with plain cylindrical straight shank.

With axial stop screw.

Can use tools with through coolant channels.

HERMÉTICA - 100% ACERO

Para herramientas con mango cilíndrico liso.  
Con regulación axial de herramienta.

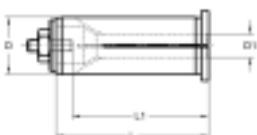

COD.	D	L	L <sub>1</sub> (max)	D <sub>1</sub>
002 09 14	20	52,5	46	6-8-10 ..... 14-16
002 09 16	32	64,5	58	6-8-10 ..... 20-25

- Forma de pedido: COD. + D<sub>1</sub>  
EJEMPLO: 002 05 16/10

- To order: COD. + D<sub>1</sub>  
EXAMPLE: 002 05 06/10

(\* It can be used with coolant trough cutting tools (except Ø 3). In this case plain cylindrical shank should be used and the cutting tool should cover completely the internal grinded surface as indicated in the drawing.

(\* Puede ser utilizado con herramientas con paso de refrigerante (excepto Ø 3). Para ello el mango debe ser cilíndrico y ocupar la totalidad de la zona rectificada interiormente según muestra el dibujo.

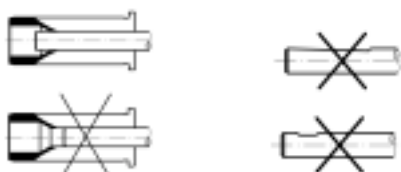

### 002 20 00 . . . .

Reducing adapters  
Reductores para adaptadores portamachos

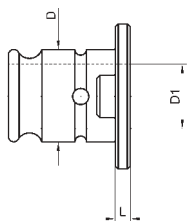

COD.	D	L	D <sub>1</sub>
002 20 00 02 01	19	4	13
002 20 00 03 01	31	5	13
002 20 00 03 02	31	5	19
002 20 00 04 02	48	6	19
002 20 00 04 03	48	6	31

### 002 21 . . . . .

Positive drive adapters  
Sin embrague

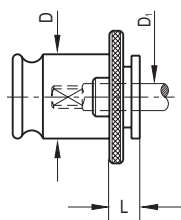

COD.	D	L	D <sub>1</sub>
002 21 01	13	7	2,5-2,8-3,15-3,5-3,55-4-4,5-5-5,5-5,6-6-6,3-7-7,1-8
002 21 02	19	7	3,15-3,5-3,55-4-4,5-5-5,5-5,6-6-6,3-7-7,1-8-9-10-11-11,2
002 21 03	31	11	6-6,3-7-7,1-8-9-10-11-11,2-12-12,5-14-16-18
002 21 04	48	14	11-11,2-12-12,5-14-16-18-20-22-25-28

### 002 22 . . . . .

Positive drive adapters for light machining only  
Sin embrague y trabajos de poco esfuerzo

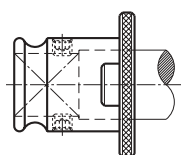

COD.	D	L	D <sub>1</sub>
002 22 02	19	4	12
002 22 03	31	5	20-22
002 22 04	48	6	32-36

### 002 23 . . . . .

Positive drive adapters  
Con embrague

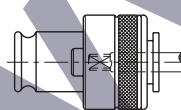

COD.	D	L	D <sub>1</sub>
002 23 01	13	21	2,5-2,8-3,15-3,5-3,55-4-4,5-5-5,5-5,6-6-6,3-7-7,1-8
002 23 02	19	25	3,15-3,5-3,55-4-4,5-5-5,5-5,6-6-6,3-7-7,1-8-9-10-11-11,2
002 23 03	31	34	6-6,3-7-7,1-8-9-10-11-11,2-12-12,5-14-16-18
002 23 04	48	45	11-11,2-12-12,5-14-16-18-20-22-25-28

### 002 24 . . . . .

Torque release (with clutch) adapters for light machining only  
Con embrague y trabajos de poco esfuerzo

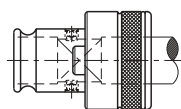

COD.	D	L	D <sub>1</sub>
002 24 02	19	32	12
002 24 03	31	31	20-22
002 24 04	48	41	32-36

- To order: COD. + D<sub>1</sub> x □ - EXAMPLE: 002 21 02 / 3,15 x 2,5

- Forma de pedido: COD. + D<sub>1</sub> x □ mango - EJEMPLO: 002 21 02 / 3,15 x 2,5

For cylindrical straight shanks with square DIN 10

002 51 ... ..

DIN 6328

Tapping collets

For tools with cylindrical straight shank with square DIN 10

Sujeción de mangos cilíndricos con cuadradillo de arrastre DIN 10

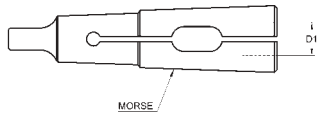

COD.	Morse N°	D <sub>1</sub>
002 51 02	1	2,5 ..... 12,5
002 51 03	2	8 ..... 18
002 51 04	3	8 ..... 18

- To order: COD. + D<sub>1</sub>  
EXAMPLE: 002 51 02/5

- Forma de pedido: COD. + D<sub>1</sub>  
EJEMPLO: 002 51 02/5

002 52 ... ..

DIN 6329

Drill collets

For tools with cylindrical straight shank according to DIN 1809

Pinza para broca.

Sujeción de mangos cilíndricos con arrastre DIN 1809

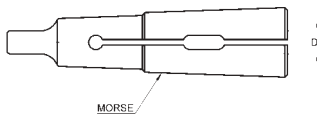

COD.	Morse N°	D <sub>1</sub>
002 52 01	0	1,6 ..... 8
002 52 02	1	5,5 ..... 13
002 52 03	2	8 ..... 18
002 52 04	3	3 ..... 18

- To order: COD. + D<sub>1</sub>  
EXAMPLE: 002 52 02/5

- Forma de pedido: COD. + D<sub>1</sub>  
EJEMPLO: 002 52 02/5

002 54 ... ..

ISO DIN 2080 Taper

Cono ISO DIN 2080

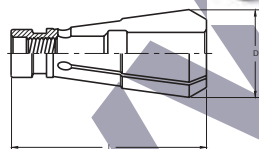

COD.	K	D	L	D <sub>1</sub>
002 54 01	30	31,75	76	2 ..... 18
002 54 02	40	44,45	102	4 ..... 28

- To order: COD. + D<sub>1</sub>  
EXAMPLE: 002 54 01/10

- Forma de pedido: COD. + D<sub>1</sub>  
EJEMPLO: 002 54 01/10

002 55 ... ..

R-8 Bridgeport

Cono R-8 Bridgeport

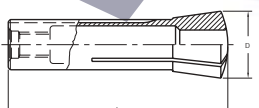

COD.	D	L	D <sub>1</sub>
002 55 01	31,75	105	3 ..... 18

- To order: COD. + D<sub>1</sub>  
EXAMPLE: 002 55 01/10

Material: Tempered spring steel.  
Rc 56 – 58

Collet /Pinza		Collet set Juego de pinzas	Collet chuck Portapinzas	Nº de SET	Box / Estuche			Wrench Llave	
Type Tipo	Size Tamaño				COD.	Dimensions Dimensiones			
						A	B		C
DIN 6388	002 01 04	4-5-6-7-8-9-10-11-12 13-14-15-16-18-20	004xx01xx04	02	004 99 05 02 04	240	215	78	004 99 04 09 09
	002 01 05	4-5-6-7-8-9-10-11-12 13-14-15-16-18-20-25	004xx01xx04	02	004 99 05 02 05 Morse 3 - 4 R8 ISO 30 y 40	315	295	78	004 99 04 09 09
					004 99 05 04 05 Morse 5 ISO 50	450	340	123	
002 01 06	6-7-8-9-10-11-12-13 14-15-16-18-20-25-32	004xx01xx06	02	004 99 05 14 06	445	295	120	004 99 04 09 12	
DIN 6499 Tipo ER	ER 25	2-3-4-5-6-7-8-9-10-11 12-13-14-15-16	004xx06xx05	02	004 99 05 02 03 ISO 30 y 40	245	210	76	004 99 04 03 05
	ER 32				004 99 05 02 05 Morse 3 - 4 R8 ISO 30 y 40	315	295	98	004 99 04 03 06
					004 99 05 04 05 Morse 5 ISO 50	450	300	123	
ER 40	2-3-4-5-6-7-8-9-10-11 12-13-14-15-16	004xx06xx07	02	004 99 05 14 06	445	295	128	004 99 04 03 07	
GREAT POWER GRAN APRIETE	0020514				004 99 25 02 04; SK 40, 50	305	165	85	
		4-6-8-10-12-16	004xx15xx04	03	004 99 25 04 06; HSK 63, 100	320	300	125	004 99 04 09 09
	0020516	6-8-10-12-16-20-25	004xx15xx06	02	004 99 25 04 06; ISO 30; 40; 50; HSK 63; HSK 100	320	300	125	004 99 04 09 11



To order:  
CHUCK COD. / SET Nº  
EXAMPLE: 004 01 01 04 05 / 02

Forma de pedido:  
CODIGO DE PORTAPINZAS. / Nº SET  
EJEMPLO: 004 01 01 04 05 / 02

Collet / Pinza	Container / Contenedor vacío			Collets set Juego de pinzas	Cod. of collets set without container Código del juego de pinzas sin contenedor	Cod. of collets set with container Código del conjunto de pinzas y contenedor/es	
	COD.	Dimensions Dimensiones					
		A	B				C
ER - 11	004 99 99 11 02	210	22	13	1 - 1,5 - 2 - 2,5 - 3 - 3,5 - 4 4,5 - 5 - 5,5 - 6 - 6,5 - 7	002 11 02 00 00 01	002 11 02 00 00 11
ER - 16	004 99 99 11 03	280	35	20	1 - 2 - 3 - 4 - 5 - 6 - 7 - 8 9 - 10	002 11 03 00 00 01	002 11 03 00 00 11
ER - 25	004 99 99 11 05	280	75	25	2 - 3 - 4 - 5 - 6 - 7 - 8 - 9 - 10 11 - 12 - 13 - 14 - 15 - 16	002 11 05 00 00 01	002 11 05 00 00 11
ER - 32	004 99 99 11 06	340	90	32	3 - 4 - 5 - 6 - 7 - 8 - 9 10 - 11 - 12 - 13 - 14 - 15 16 - 17 - 18 - 19 - 20	002 11 06 00 00 01	002 11 06 00 00 11
ER - 40	004 99 99 11 07	270	205	30	4 - 5 - 6 - 7 - 8 - 9 - 10 11 - 12 - 13 - 14 - 15 - 16 17 - 18 - 19 - 20 - 21 - 22 23 - 24 - 25 - 26	002 11 07 00 00 01	002 11 07 00 00 11
ER - 50	004 99 99 11 08	275	185	43	12 - 14 - 16 - 18 - 20 - 22 24 - 26 - 28 - 30 - 32 - 34	002 11 08 00 00 01	002 11 08 00 00 11

Collet / Pinza	Container / Contenedor vacío			Collets set Juego de pinzas	Cod. of collets set without container Código del juego de pinzas sin contenedor	Cod. of collets set with container Código del conjunto de pinzas y contenedor/es	
	COD.	Dimensions Dimensiones					
		A	B				C
ER - 16	004 99 99 11 03	280	35	20	3 - 4 - 5 - 6 - 7 - 8 9 - 10	002 15 03 00 00 01	002 15 03 00 00 11
ER - 25	004 99 99 11 05	280	75	25	3 - 4 - 5 - 6 - 7 - 8 - 9 - 10 11 - 12 - 13 - 14 - 15 - 16	002 15 05 00 00 01	002 15 05 00 00 11
ER - 32	004 99 99 11 06	340	90	32	3 - 4 - 5 - 6 - 7 - 8 - 9 10 - 11 - 12 - 13 - 14 - 15 16 - 17 - 18 - 19 - 20	002 15 06 00 00 01	002 15 06 00 00 11
ER - 40	004 99 99 11 07	270	205	30	4 - 5 - 6 - 7 - 8 - 9 - 10 11 - 12 - 13 - 14 - 15 - 16 17 - 18 - 19 - 20 - 21 - 22 23 - 24 - 25 - 26	002 15 07 00 00 01	002 15 07 00 00 11

